

# PUSH TO OPEN

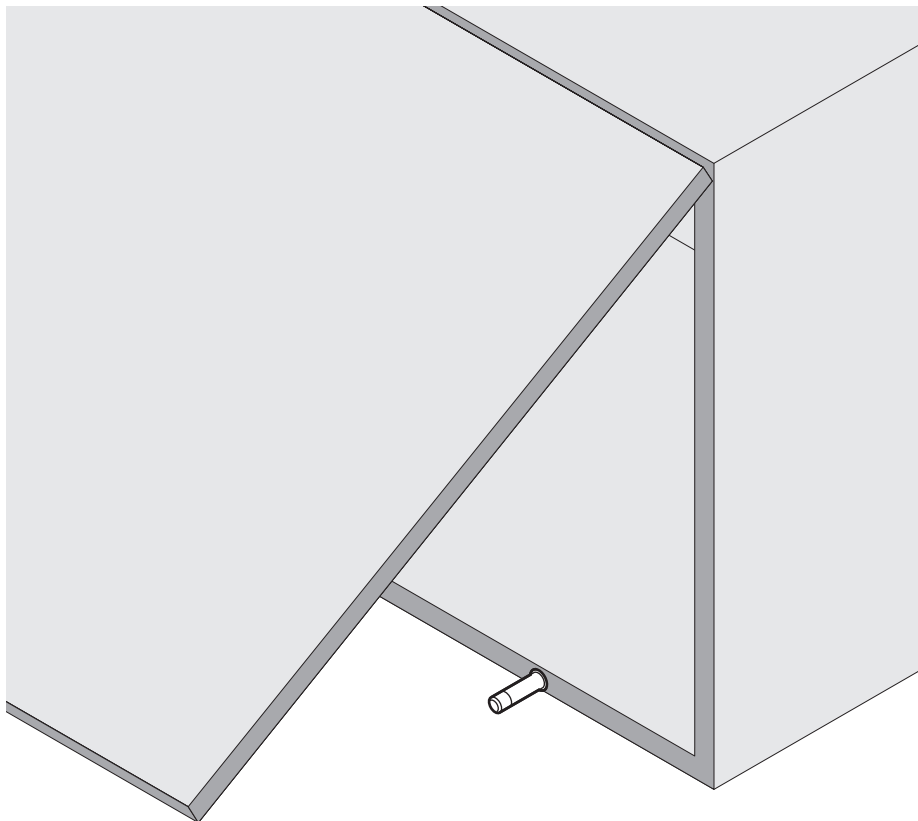

Für grifflose Fronten  
Pour façades sans poignées  
For handle-free unit fronts

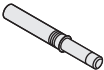

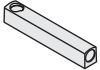

Art.Nr. <b>Typ I</b> 500.0300.xx <b>Typ II</b> 500.0301.xx <b>Typ III</b> 500.0302.xx
1x 

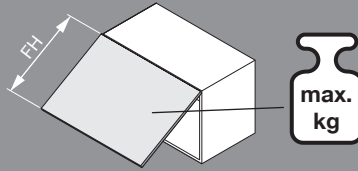
<b>Option</b>
1x  500.0303.18



**FREEflap mini**

FREEflap	FH	 × 1			 × 2	
		Typ I	Typ II	Typ III	Typ II	Typ III
A B C	250	1.3-3.1 kg	3.1-3.8 kg	-	-	-
		-	2.9-5.1 kg	5.1-6.4 kg	-	-
		-	-	5.4-6.9 kg	6.9-10.5 kg	10.5-11.8 kg
	275	1.2-3.0 kg	3.0-3.3 kg	-	-	-
		2.5-3.3 kg	3.3-5.0 kg	5.0-5.7 kg	-	-
		-	-	4.8-6.8 kg	6.8-10.0 kg	10.0-10.6 kg
	300	1.1-2.7 kg	2.7-3.1 kg	-	-	-
2.4-3.0 kg		3.0-4.6 kg	4.6-5.1 kg	-	-	
-		-	4.4-6.6 kg	6.6-9.6 kg	-	
325	1.0-2.6 kg	2.6-2.8 kg	-	-	-	
	2.1-3.0 kg	3.0-4.2 kg	4.2-4.6 kg	-	-	
	-	-	4.0-6.0 kg	6.0-8.8 kg	-	
350	0.9-2.4 kg	2.4-2.6 kg	-	-	-	
	2.0-2.9 kg	2.9-4.2 kg	-	-	-	
	-	3.7-3.9 kg	3.9-5.9 kg	5.9-8.1 kg	-	
375	0.9-2.3 kg	-	-	-	-	
	1.9-2.7 kg	2.7-3.8 kg	-	-	-	
	-	3.5-3.9 kg	3.9-5.7 kg	5.7-7.5 kg	-	
400	0.8-2.1 kg	-	-	-	-	
	1.7-2.7 kg	2.7-3.6 kg	-	-	-	
	-	3.2-3.8 kg	3.8-5.6 kg	5.6-7.0 kg	-	
D E F G	400	-	4.7-9.0 kg	9.0-9.6 kg	-	-
		-	5.9-7.9 kg	7.9-11.6 kg	11.6-12.4 kg	-
		-	-	8.9-10.7 kg	10.7-17.2 kg	17.2-18.6 kg
		-	-	11.8-12.3 kg	12.3-17.9 kg	17.9-23.3 kg
	450	4.1-5.0 kg	5.0-8.4 kg	-	-	-
-		5.2-7.9 kg	7.9-10.9 kg	-	-	
-		-	7.8-10.2 kg	10.2-16.3 kg	-	
-		-	10.4-10.8 kg	10.8-16.7 kg	16.7-20.5 kg	
500	3.7-4.9 kg	4.9-7.5 kg	-	-	-	
	-	4.7-7.8 kg	7.8-9.7 kg	-	-	
	-	-	7.0-10.0 kg	10.0-14.6 kg	-	
	-	-	9.2-10.7 kg	10.7-16.0 kg	16.0-18.3 kg	
550	3.3-4.9 kg	4.9-6.8 kg	-	-	-	
	4.2-4.5 kg	4.5-7.5 kg	7.5-8.8 kg	-	-	
	-	6.3-6.8 kg	6.8-9.7 kg	9.7-13.2 kg	-	
	-	-	8.3-10.4 kg	10.4-15.3 kg	15.3-16.5 kg	
600	3.0-4.7 kg	4.7-6.2 kg	-	-	-	
	3.8-4.2 kg	4.2-7.2 kg	7.2-8.0 kg	-	-	
	-	5.7-6.7 kg	6.7-9.2 kg	9.2-12.0 kg	-	
	-	-	7.6-10.2 kg	10.2-15.0 kg	-	

**FREEflap forte**

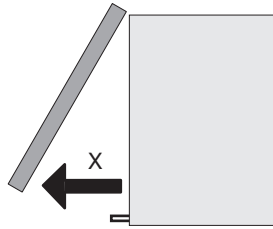

	Typ I	Typ II	Typ III
X	17-23 N	22-34 N	26-48 N

500.0303.18

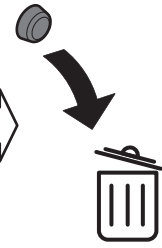
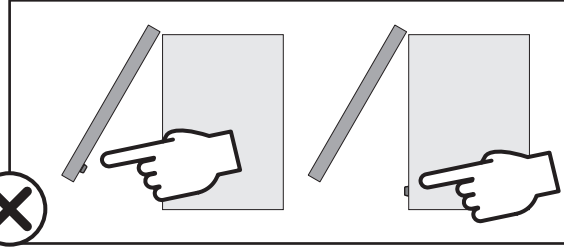
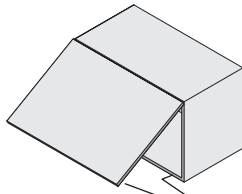
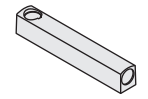

1

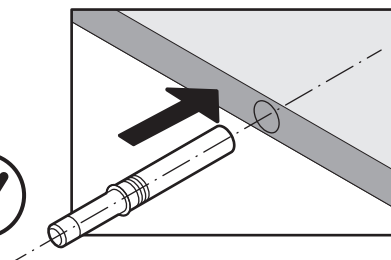
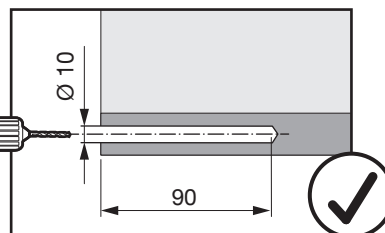
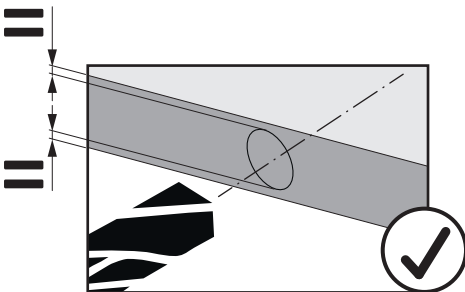
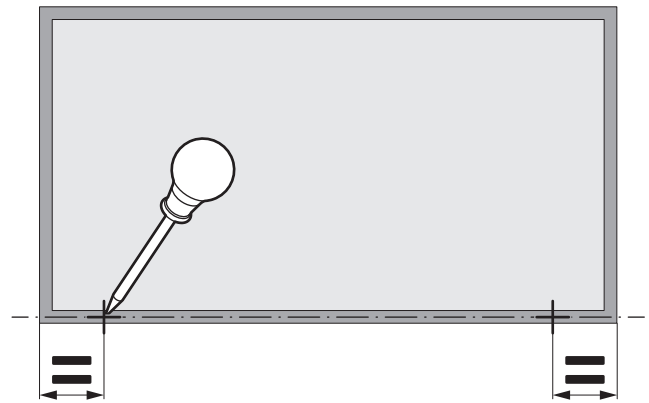
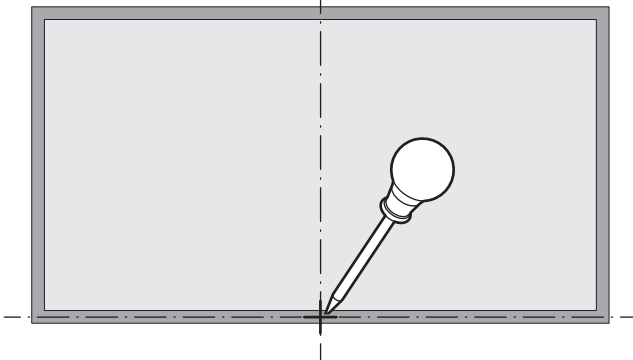
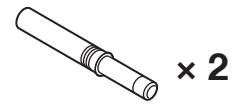
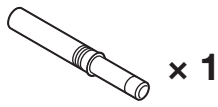
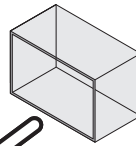
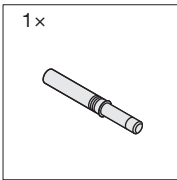

500.0303.18

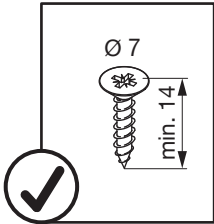
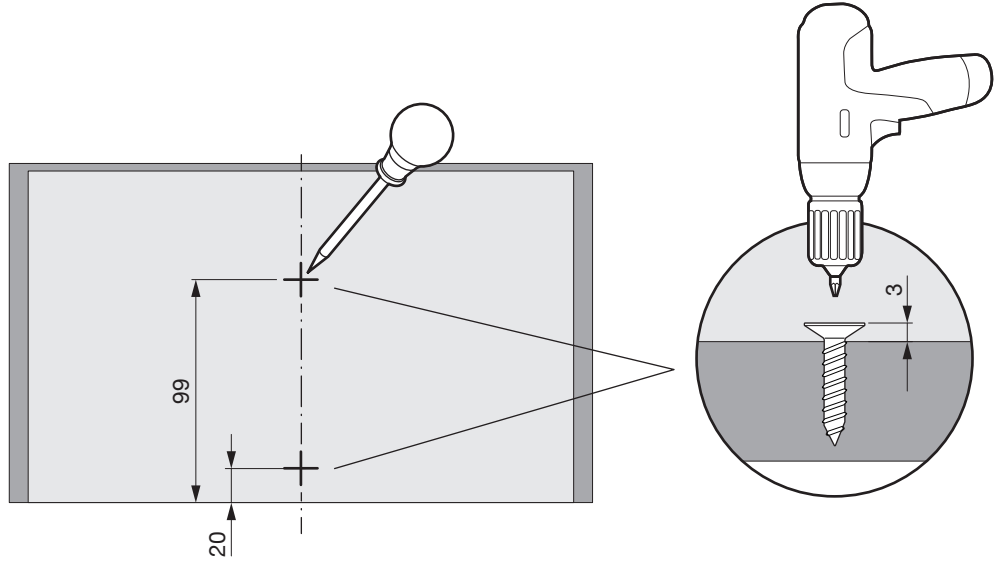
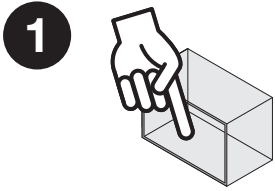
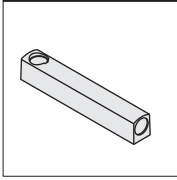

**2**

